

# Mixu 02

## Design in collaboration with Gensler, 2025

### Art. 5832

Chair on a four-legged base in chromed or powder-coated steel. Seat upholstered with Elmosoft leather or Valencia coated fabric. Backrest upholstered with an alternative material than the one used for the seat, chosen from the Arper portfolio or customer's own material. The upholstery can be separated and replaced by technical personnel, since it has been applied without the use of glue.



#### Dimensions \*

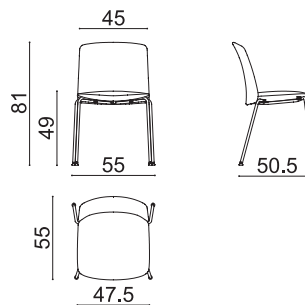

\* File CAD 2D - 3D available for download at [www.arper.com](http://www.arper.com)

#### Frame Base

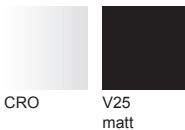







# Mixu 02

## Design in collaboration with Gensler, 2025

---

### SHIPMENT DETAILS

**Art.5832**

1 pz = 1  - kg 8,61/ m<sup>3</sup> 0,169  
1 pz = 1  - kg 9/ m<sup>3</sup> 0,326  
2 pz = 1  - kg 16,02/ m<sup>3</sup> 0,234  
2 pz = 1  - kg 16,11/ m<sup>3</sup> 0,383  
4 pz = 1  - kg 28,33/ m<sup>3</sup> 0,476  
4 pz = 1  - kg 30/ m<sup>3</sup> 0,328

### TECHNICAL SPECIFICATIONS

Art.5832

COL requirement m<sup>2</sup> 2.28

H 140 cm. COM Meterage m 1.18