

# Saari S

Design by Lievore Altherr Molina, 2009

## Art. 2710

Armchair (71 cm wide seat) with polished or powder-coated four-leg steel base, or with oak effect reconstituted veneer base. Upholstered shell with metal and plywood frame available in leather, coated fabric, fabric or customer's material. Fully removable cover version available upon request without surcharge.



Dimensions \*

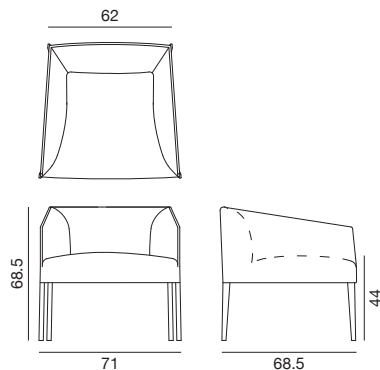

\* File CAD 2D - 3D available for download at [www.arper.com](http://www.arper.com)

Frame Base

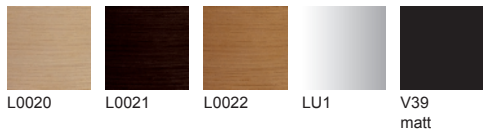

arper

www.arper.com

info@arper.com

# Saari S

## Design by Lievore Altherr Molina, 2009

---

Accessories:

Replacement cover set Art.  
2715

USB Art. 6001

---

### SHIPMENT DETAILS

**Art.2710**

1 pz = 1  - kg 25/ m³ 0,666

---

### TECHNICAL SPECIFICATIONS

Art.2710

COL requirement m² 4.51

H 140 cm. COM Meterage m 2.75

---





FIRE RETARDANT TEST

---

FIRE RETARDANT TEST

arper

www.arper.com  
info@arper.com

-  Upholstery
-  Multi density polyurethans
-  Mono density polyurethans
-  Ovatet and velveteen
-  Wooden structure

