

Arcos

Design by Lievore Altherr, 2017

Art. 6101

Armchair with sled base and integrated armrests made of powder-coated aluminum. Shell in metal and plywood is upholstered in fabric, leather, coated fabric or customer's own material. The upholstery can be separated and replaced by technical personnel, since it has been applied without the use of glue. Arper Grade: SOFA.



Dimensions *

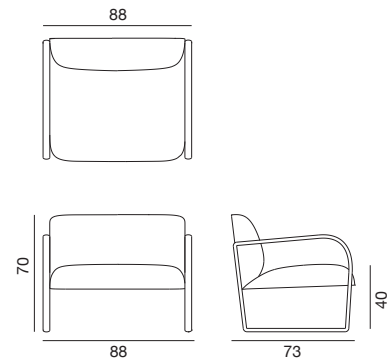

* File CAD 2D - 3D available for download at www.arper.com

Frame Base



V39
matt



V59
matt



V60
matt



V61
matt



V62
matt

arper

www.arper.com

info@arper.com

Arcos

Design by Lievore Altherr, 2017

Accessories:

USB Art. 6001

Replacement cover set Art.
6104



Armrests CI - only pad

SHIPMENT DETAILS

Art.6101

1 pz = 1  - kg 24,722/ m³

1 pz = 1  - kg 27,96/ m³ 0,901

TECHNICAL SPECIFICATIONS

Art.6101

COL requirement m² 5,46

H 140 cm, COM Meterage m 2,48

*Classe 1, 2, 1IM: fire retardant version available with
surcharge and eventual minimum batch

FIRE RETARDANT TEST

Thickness

arper





GLIDES

Standard

Optional

www.arper.com info@arper.com

www.arper.com

-  Upholstery
-  Mono density polyurethan 1
-  Mono density polyurethan 2
-  Ovatet and velveteen
-  Wooden structure

