

Pix

Design by Ichiro Iwasaki, 2019

Art. 3022

One small seat ottoman. Upholstery available in fabric, leather, coated fabric or customer's material. Available in outdoor version thanks to a water-repellent inner lining in coated polyester. Fitted with glides. 67 cm diameter and 43 cm height.



Dimensions *

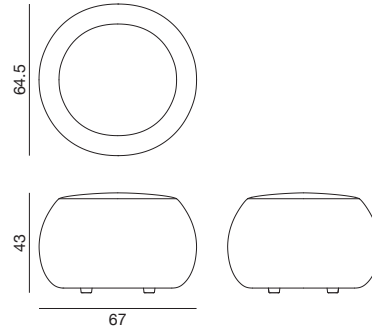

* File CAD 2D - 3D available for download at www.arper.com

arper

www.arper.com

info@arper.com

Pix

Design by Ichiro Iwasaki, 2019

Accessories:

Replacement cover set Art.
3004

SHIPMENT DETAILS

Art.3022

1 pz = 1  - kg 5,4/ m³

1 pz = 1  - kg 8/ m³ 0,215





TECHNICAL SPECIFICATIONS

Art.3022

H 140 cm. COM Meterage m 1.6

arper

www.arper.com
info@arper.com

-  Upholstery
-  Multi density polyurethans
-  Polystyrene
-  Velveteen
-  Wooden structure

